

1

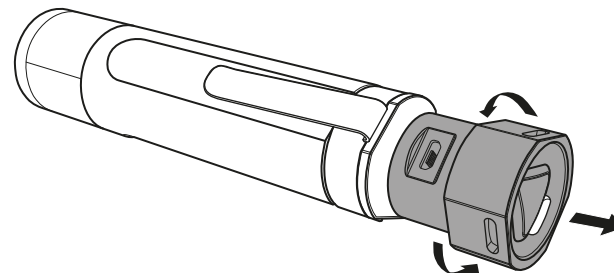

TWIST

2

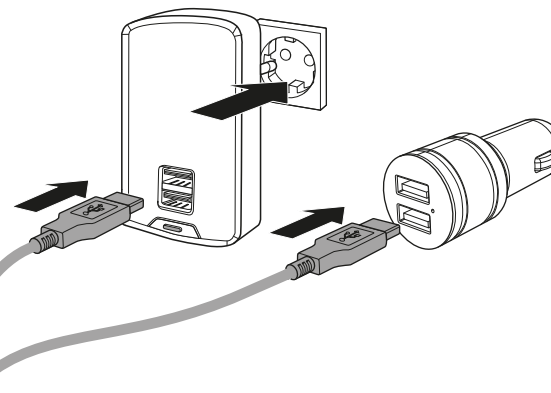
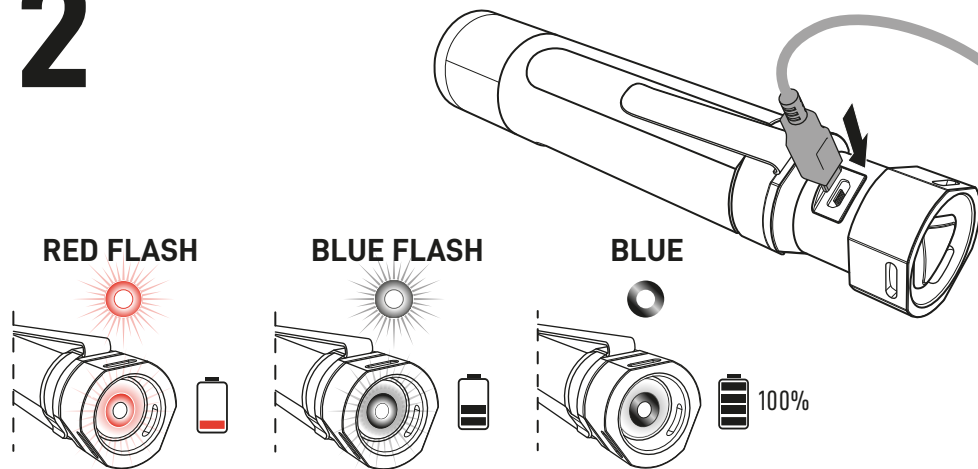

5V/500-2000 mA

3 a)

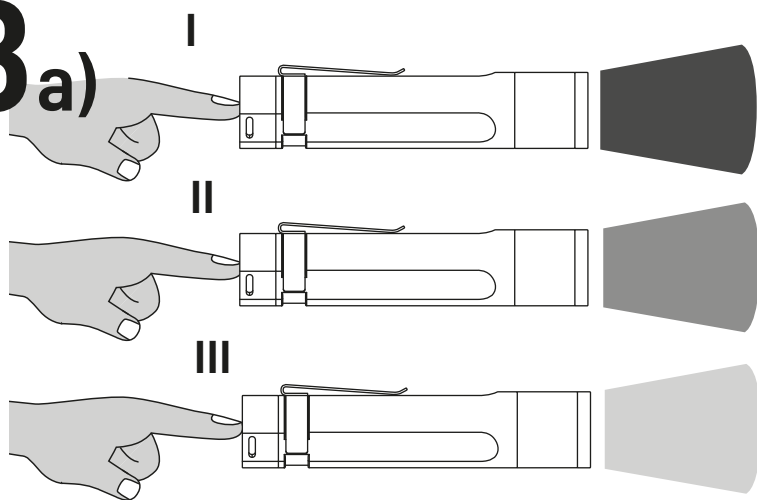

b)

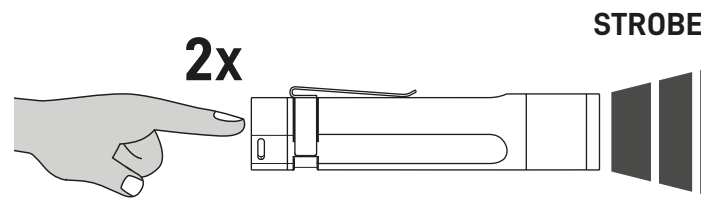

STROBE

c)

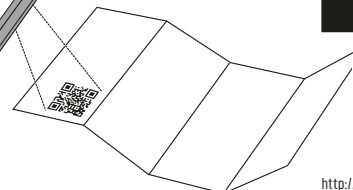
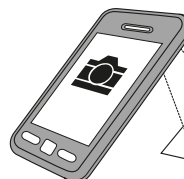
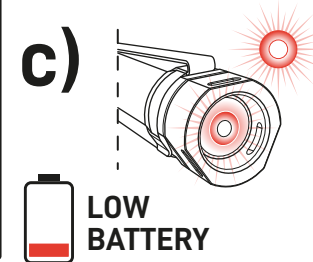

**VARTA**



18900  
750 969

<http://www.varta-consumer.com>